



USER MANUAL
**BEACON
SOUNDER**

we watch gas where you can't

CONTENTS

DESCRIPTION	3
WARNING	3
DISPOSAL	3
1. PRODUCT OVERVIEW	4
1.1 PCB Layout	4
1.2 Drilling Template	4
2. DIP SWITCH SETTINGS	5
3. MOUNTING INSTRUCTIONS	7
4. SPECIFICATION	8
5. SERIAL PROTOCOL SPECIFICATION	8
6. LIMITED WARRANTY	13

DESCRIPTION

The Beacon sounder has 38 Ultra Bright, RGB LEDs with 360° visibility and Piëzo sounder, 106 dB at 30 cm. The visual and audible modes can be used independently or combined in any required combination by analog or digital trigger.

IMPORTANT: This user manual contains important information regarding the operation of the beacon sounder. Ensure you read this user manual fully before installing and operating the beacon sounder. If you are installing this beacon sounder for use by others, you must leave this manual with the end user. Installation must be carried out, in accordance with latest codes and regulations, by a qualified electrician.

WARNING

- Ensure power source is disconnected prior to installation or maintenance to avoid damage to the beacon sounder or electric shock.
- Do not handle internal electrical components whilst wiring up. Environmental exposure during installation should be under dry circumstances, avoid heavy moist and wet conditions. The beacon sounder is only weatherproof to IP65 when mounted upright.
- Use M4 screws, washers and nuts (4 pieces supplied) to secure beacon to its mounting. Do not mount the beacon sounder on places with excessive vibrations.
- Do not use solvents or cleaners on the beacon sounder, as they may cause damage to the beacon lens or circuitry. The unit can be wiped with a slightly damp cloth.

DISPOSAL

The beacon sounder should not be disposed with your other household waste. The beacon sounder is ideally suited for disposal within the waste electronic and electrical equipment (WEEE) recycling scheme. Check at your local authority, retailer or contact our technical support team for recycling / disposal advice as regional variations apply. You may return the unit to us for safe dismantling and disposal.



BEACON SOUNDER

1. PRODUCT OVERVIEW

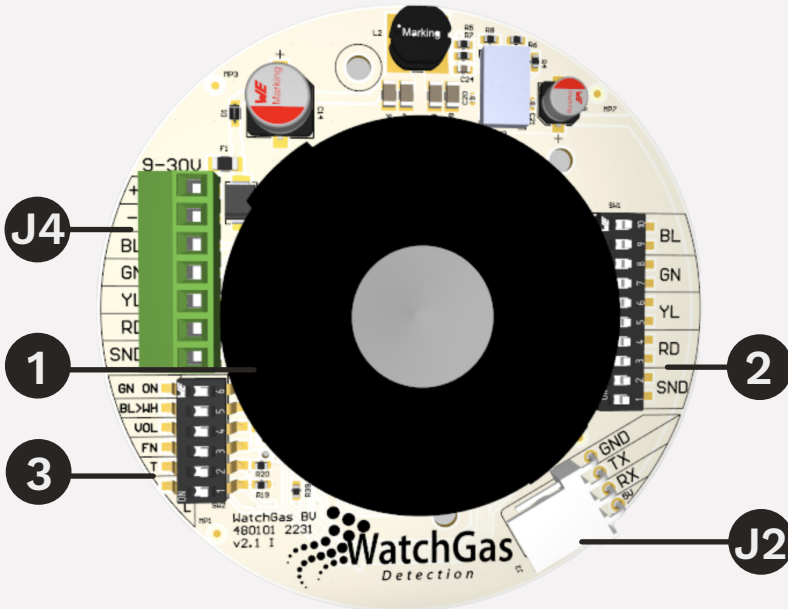

1.1 PCB LAYOUT

- 1. Sounder
- 2. 10 pin DIP switch
- 3. 6 pin DIP switch
- J2. Communication input
- J4. Terminal block 7 pins
- + = Supply
- = Ground
- BU = Blue light
- GN = Green light
- YL = Yellow light
- RD = Red light
- SND = Sounder

POWER SUPPLY	9-30V DC (min. 4W)
STAND-BY CURRENT	max 10mA
TRIGGER VOLTAGE POSITIVE	6-30V DC
TRIGGER CURRENT	max 6mA
CABLE DIAMETER	max 1.3mm ² Stranded core

1.2 DRILLING TEMPLATE

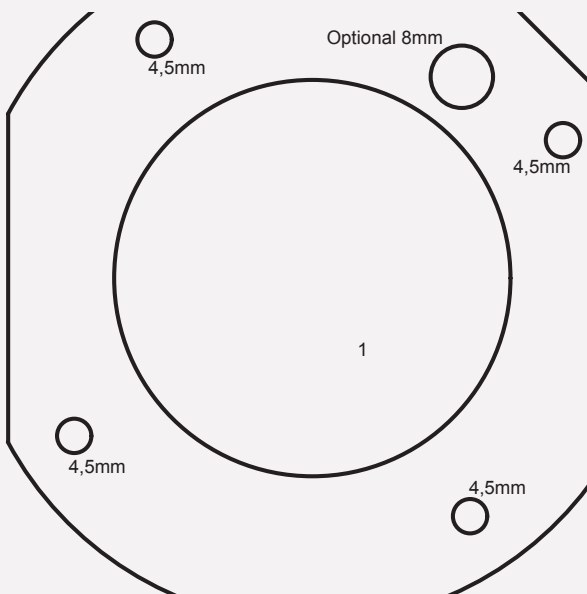

Drilling Template Scale 1/1

2. DIP SWITCH SETTINGS

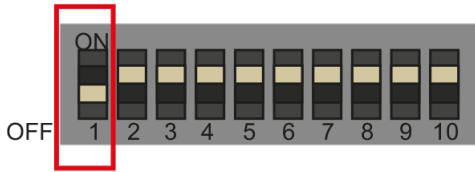

DIP SWITCH 1 / 2 SOUND SELECTION



alternating low / high beeps



continuous 50 Hz



changing frequency fast



continuous 2700 Hz

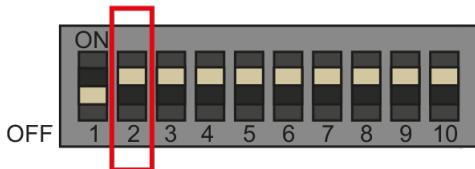

DIP SWITCH 3 / 4 RED LIGHT



continuous



fancy loop



looping



flashing 10 Hz / 50% duty cycle



DIP SWITCH 5 / 6 YELLOW LIGHT



continuous



fancy loop



looping



flashing 10 Hz / 50% duty cycle

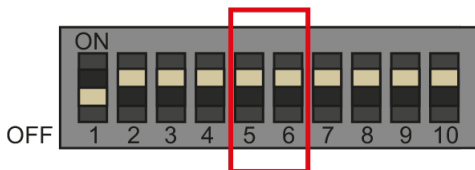

DIP SWITCH 7 / 8 GREEN LIGHT



continuous



fancy loop



looping



flashing 10 Hz / 50% duty cycle



DIP SWITCH 9 / 10 BLUE / WHITE LIGHT



continuous



fancy loop



looping



flashing 10 Hz / 50% duty cycle



BEACON SOUNDER



DIP SWITCH 1 L

Link red and Sounder analog inputs

ON = Linked
OFF = Unlinked

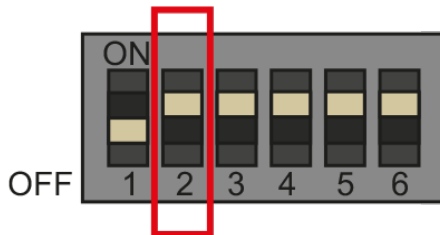

DIP SWITCH 2 T

Trigger

ON = Rising trigger
OFF = Falling trigger

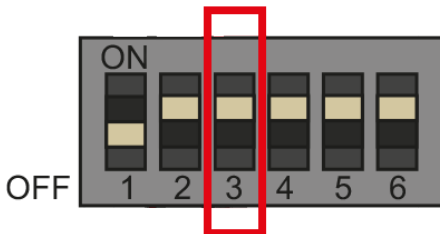

DIP SWITCH 3 FN

Function

ON = J2 TTL Communication protocol
OFF = J4 terminal block input

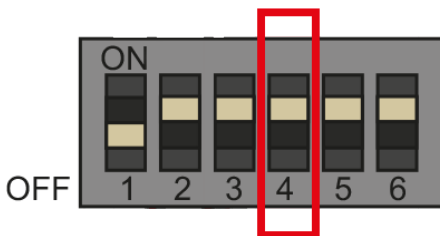

DIP SWITCH 4 VOL

Volume

ON = Low
OFF = High



DIP SWITCH 5 BL>WH

Swap blue to white

ON = Active
OFF = Not active

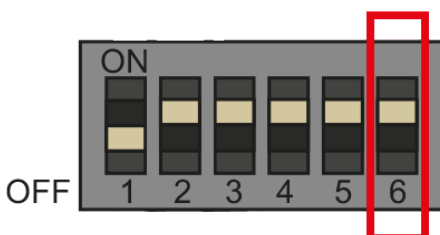

DIP SWITCH 6 GN ON

Green always on

ON = Active
OFF = Not active

3. MOUNTING INSTRUCTIONS

- Use drilling template to make holes in the mounting surface.
- Mount the beacon sounder with the supplied screws, washers and nuts.
- Always mount with the glass upright.
- Ensure all rubber gaskets are placed correctly.
- Insert Supply/signal cable through the 5,5mm hole (see drilling template)
- Connect supply/signal cable to the terminal block

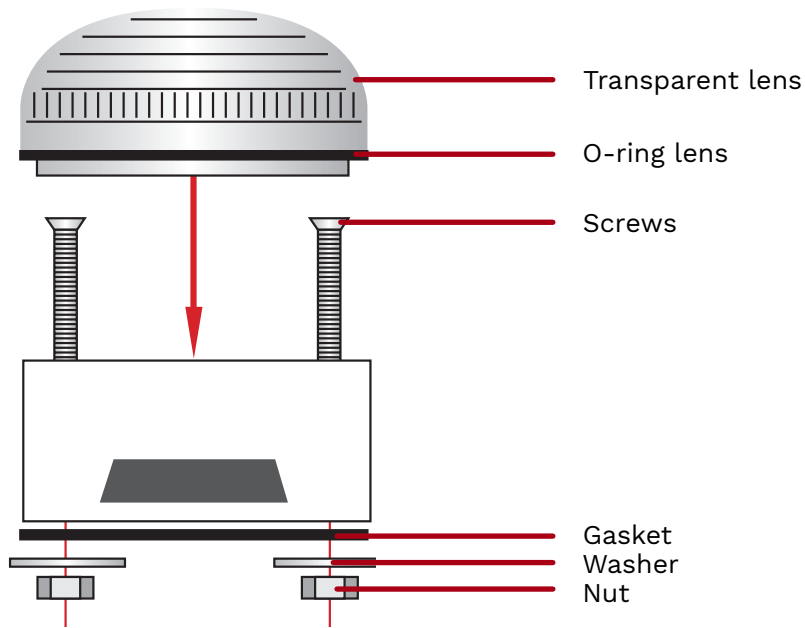

CAUTION

Only mount in upright position as shown.

CONNECTION EXAMPLE NORMAL TRIGGER

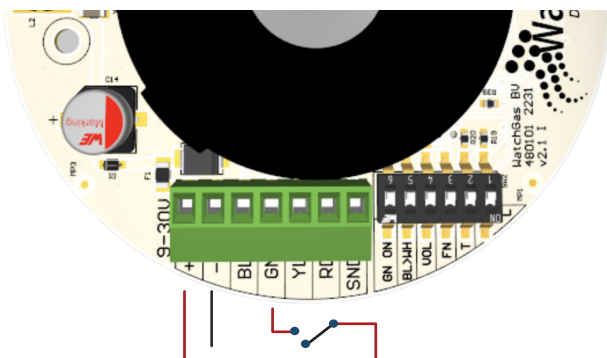

CONNECTION EXAMPLE INVERTED TRIGGER

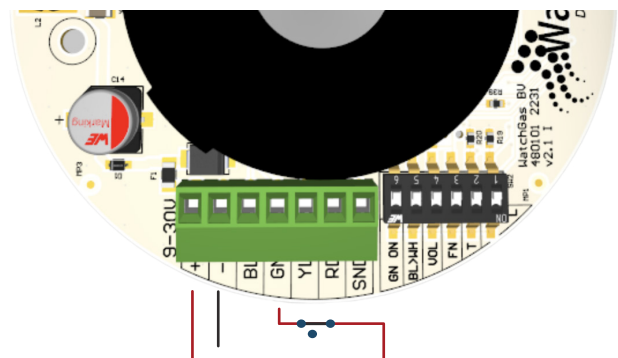

4. GENERAL SPECIFICATIONS

DIMENSIONS	92 x 83 mm (3.6 x 3.3”) Dia x H
WEIGHT	250 g (8.82 oz)
MOUNTING	4x M4x35 bolts
COLORS	RGB LED, Red, Yellow, Green and Blue flashing patterns
SOUND	4 types of alarm sounds
SOUND PRESSURE LEVEL	106 dB @ 30 cm
POWER SUPPLY	9-30V DC (min. 4W)
STANDBY CURRENT	Max. 10 mA
TRIGGER VOLTAGE POSITIVE	6-30V DC
TRIGGER CURRENT	Max. 6 mA
CABLE DIAMETER	Max. 1,3 mm ² Stranded core

5. SERIAL PROTOCOL SPECIFICATION

Specification rev 1.0

INTRODUCTION

This document describes how to control and connect the Beacon Sounder PN: Air-Beac-010 over a serial interface. This serial interface can be used to select colour, display effect and sound effect. If the serial input is used, the digital I/O inputs are no longer enabled. The document contains source code that can be used as an example of how to send commands to the beacon sounder.

CONNECTIONS

WIRING

The beacon sounder can be powered by **only one** of these options:

1. Use terminal J4 connect 9 – 30VDC (min 10W) to the + and – terminals
2. Use terminal J2 to connect a 5VDC (+/- 0.1V) 2A power supply. This input has no protection against overvoltage or supply reversal. Use at your own risk.

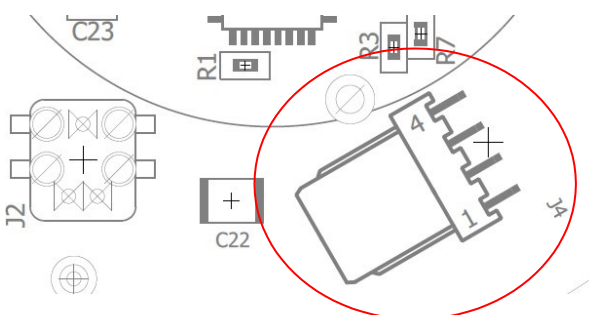

J2 PINOUT	
PIN	CONNECTION
1	+ 5VDC Power supply
2	TX Signal
3	Do not use
4	GND

NOTE

Cable length of TX signal may not exceed 500mm wire distance form signal source.

The signal voltage should be 3.3V TTL/CMOS.

CONNECTOR & CRIMP

DESCRIPTION	PART NUMBER	MANUFACTURER
WIRE-TO-BOARD RECEPTACLE	22-01-2045	Molex
CRIMP CONTACT GOLD PLATED	08-55-0111	Molex

DIPSWITCH SETTING

Set DIP switch FN 3 to “ON” to configure the beacon sounder to use a serial input.

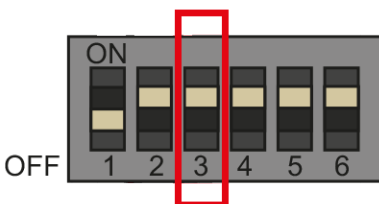

DIP SWITCH 3 FN

Function

ON = J2 TTL Communication protocol
OFF = J4 terminal block input

PROTOCOL

SPECIFICATION FOR COMMUNICATION

ITEM	VALUE
BAUD RATE	9600 8N1
FLOW CONTROL	None
SIGNALING VOLTAGE	3.3

BEACON SOUNDER

FORMAT

The serial commands consist of a 7 byte string with the following layout.

BYTE	FORMAT	DESCRIPTION
0	ASCII 'X'	Synchronization character
1	ASCII Hex	Display mode
2	ASCII Hex	Red
3	ASCII Hex	Green
4	ASCII Hex	Blue
5	ASCII Hex	Sound mode
6	ASCII Hex	CRC

All ASCII Hex values are a single value ranging from 0 to F.

NOTE

This command has to be repeated at least every 15 seconds. If no command has been received for 15 seconds, the beacon sounder will switch off.

The CRC byte is calculated as following:

crcByte = toHex ((Byte[0] + ... + Byte[5]) & 0xF);

LIGHT AND SOUND MODES

The following sound and light modes are implemented:

VALUE	SOUND MODE (BYTE 5)	LIGHT MODE (BYTE 1)
0	Disabled	Flashing 10Hz 50% duty
1	Continuous 2700Hz low	Looping
2	Changing frequency (fast) low	Fancy looping
3	Changing frequency (slow) low	Continuously on
4	Alternating low / high beeps low	Low power rotation effect
5	Continuous 50Hz low	Flashing 2Hz 10% duty
6	Reserved	Reserved
7	Reserved	Reserved
8	Disabled	Reserved
9	Continuous 2700Hz high	Reserved
A	Changing frequency (fast) high	Reserved
B	Changing frequency (slow) high	Reserved
C	Alternating low/high beeps high	Reserved
D	Continuous 50Hz high	Reserved
E	Reserved	Reserved
F	Reserved	Reserved

BEACON SOUNDER

EXAMPLE CODE

The following C code can be used to implement this protocol.

```
// Range for r,g,b is 0 .. 255.
// Run this function every 5 .. 10 seconds
void set(BSoundMode s, BLightMode m, uint8_t r, uint8_t g, uint8_t b) {

    // Transmit new values
    char cmd[9];
    cmd[0] = 'X';
    cmd[1] = toHex(m);
    cmd[2] = toHex(r >> 4);
    cmd[3] = toHex(g >> 4);
    cmd[4] = toHex(b >> 4);
    cmd[5] = toHex(s);
    cmd[6] = toHex( (cmd[0] + cmd[1] + cmd[2] + cmd[3] + cmd[4] + cmd[5]) &
0xF);
    cmd[7] = '\r';
    cmd[8] = 0;

    // Transmit
    printf((const char*) cmd);

}

char toHex(uint8_t x) {
    if (x < 10)
        return '0' + x;
    else if (x < 16)
        return 'A' + x - 10;
    else
        return '?';
}

enum BSoundMode {BS_OFF = 0, BS_CONTINUOUS_2K7 = 1, BS_LINEAR_2K7_FAST = 2, BS_
LINEAR_2K7_SLOW = 3, BS_SMALLBEEPS = 4};
enum BLightMode { BS_FAST = 0, BS_SLOW = 1, BS_LOOP = 2, BS_ON = 3, BS_TINYFLASH = 4,
BS_FULLFLASH = 5};
```

6. LIMITED WARRANTY

WATCHGAS warrants this product to be free of defects in workmanship and materials-under normal use and service-for two years from the date of purchase from the manufacturer or from the product's authorized reseller.

The manufacturer is not liable (under this warranty) if its testing and examination disclose that the alleged defect in the product does not exist or was caused by the purchaser's (or any third party's) misuse, neglect, or improper installation, testing, or calibrations. Any unauthorized attempt to repair or modify the product, or any other cause of damage beyond the range of the intended use, including damage by fire, lightening, water damage or other hazard, voids liability of the manufacturer.

In the event that a product should fail to perform up to manufacturer specifications during the applicable warranty period, please contact the product's authorized reseller or WATCHGAS service center at www.watchgas.com for repair/return information.

FOR MORE INFORMATION

www.watchgas.com
info@watchgas.com

WatchGas
Klaverbaan 121
2908 KD Capelle aan den IJssel
The Netherlands

All rights reserved. No part of this publication may be reproduced, distributed, or transmitted in any form or by any means, including photocopying, recording, or other electronic or mechanical methods, without the prior written permission of the publisher, except in the case of brief quotations embodied in critical reviews and certain other noncommercial uses permitted by copyright law. For permission requests, contact WatchGas Detection.